

SPNH SERIES SOLAR FUSE

1500 Vdc • 50-400 A • NH Style



Description

The SPNH series has been designed to meet the emerging circuit protection needs for 1500 volt photovoltaic systems. These fuses provide full range protection for all potential overcurrent conditions that exist in PV applications. Suitable for PV inverter protection and array combiner applications.

Features/Benefits

- Meets UL and IEC photovoltaic standards
- Compact NH XL Sizes
- Low Watt Loss Design
- 1500Vdc rating for high efficiency designs
- Designed to protect against a full range of overcurrents

Applications

- Inverters
- Re-combiner boxes
- Array/Re-combiner application
- PV Inverter DC input protection

Web Resources

- Download technical documents: Littelfuse.com/spnh

Specifications

Voltage Rating	1500 Vdc
Amperage Rating	50, 63, 80, 100, 125, 160, 200, 250, 315, 350, 400
Interrupting Rating	30kA
Time Constant	≤ 2ms
Material	Body: Ceramic End Bells: Copper Alloy
Approvals	UL 248-19 Listed (File: E339112, Vol. 4) IEC 60269-6
Environmental	RoHS Compliant

Part Numbering System

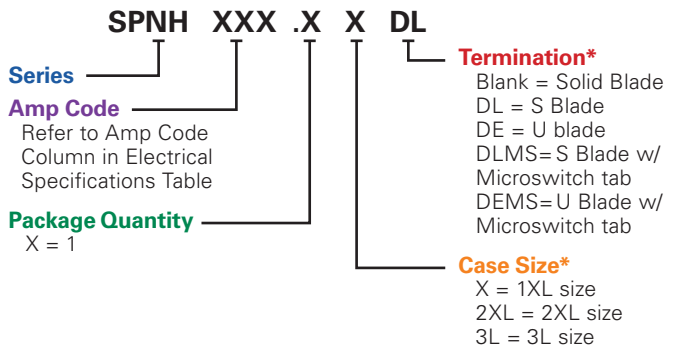

SERIES	AMP	PACKAGE QUANTITY	CATALOG NUMBER	ORDERING NUMBER
SPNH	50	1	SPNH050	SPNH050.X
SPNH	200	1	SPNH200	SPNH200.X
SPNH	400	1	SPNH400	SPNH400.XXD LMS

*Solid blade option for 1XL case size does not require a case or termination designator for the part number.

Recommended Accessories

1XL Case Size

Fuse Holder: LFNH152001CST
Fuse Terminal Covers: LFNH15200FBC

2XL Case Size

Fuse Holder: LFNH154001CST
Fuse Terminal Covers: LFNH15400FBC

3L Case Size

Fuse Holder: LFNH156301CST
Fuse Terminal Covers: LFNH15630FBC

Microswitch

MSSPNH1500X



Look for this logo to indicate products that are used in solar applications. Visit our website Littelfuse.com/solar for the latest updates on approvals, certifications, and new products.

SPNH SERIES SOLAR FUSE

Dimensions Millimeters (in)

Size: 1 XL

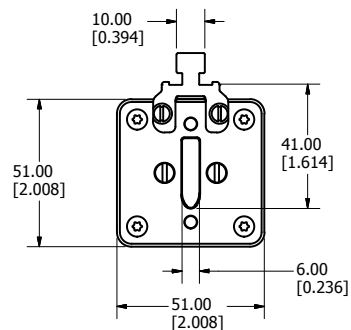
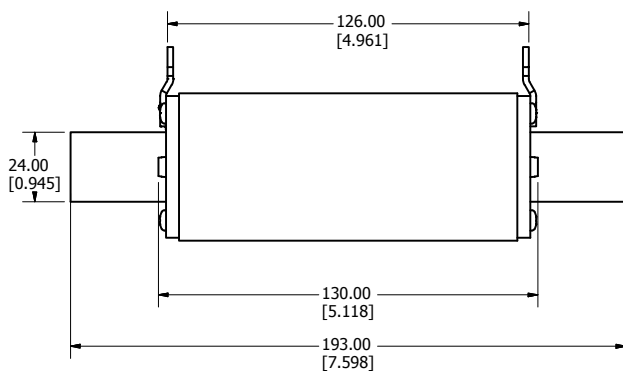

Size: 2 XL

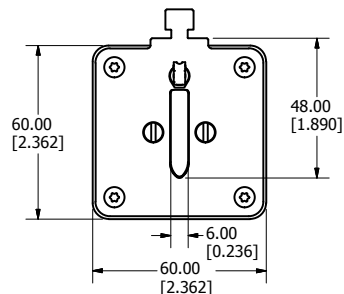
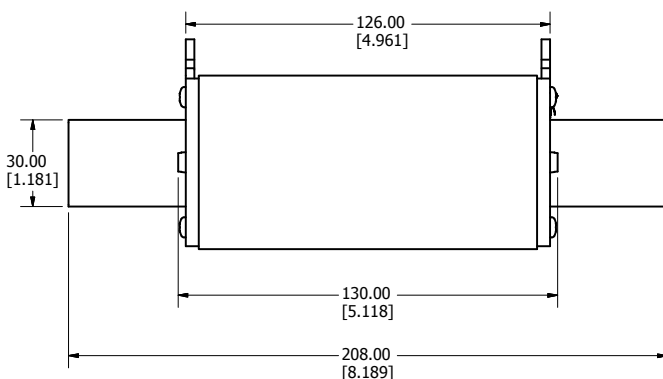

Size: 3 L

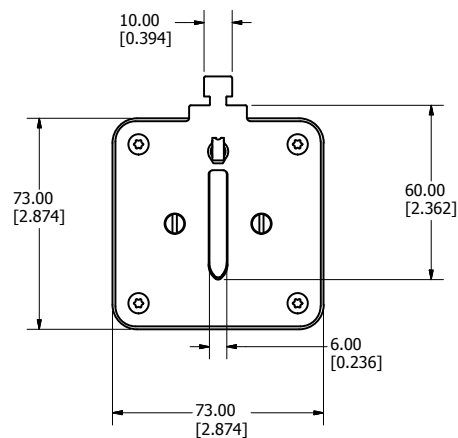
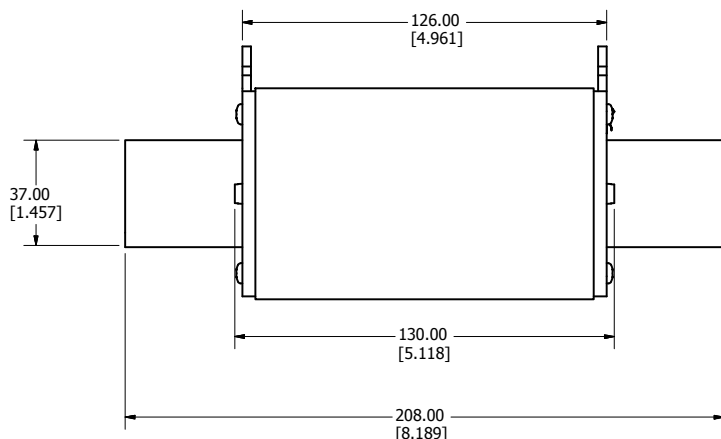

Dimensions Millimeters (in)

Size: 1XL DE Blade

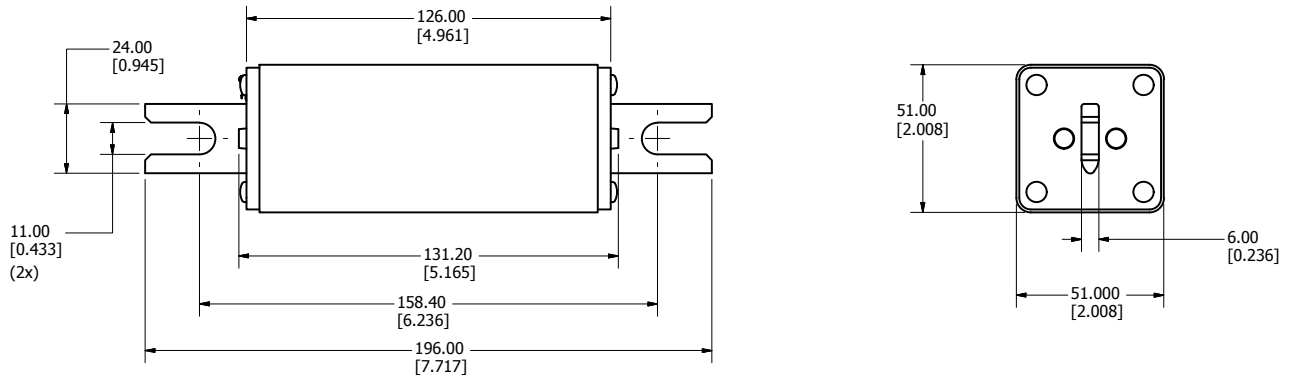

Size: 1XL DL Blade

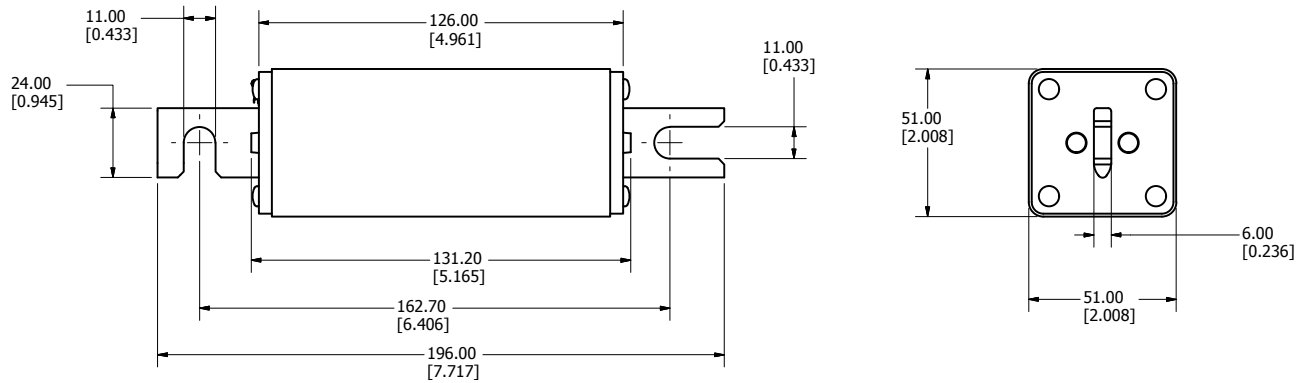

Size: 2 XL DE Blade

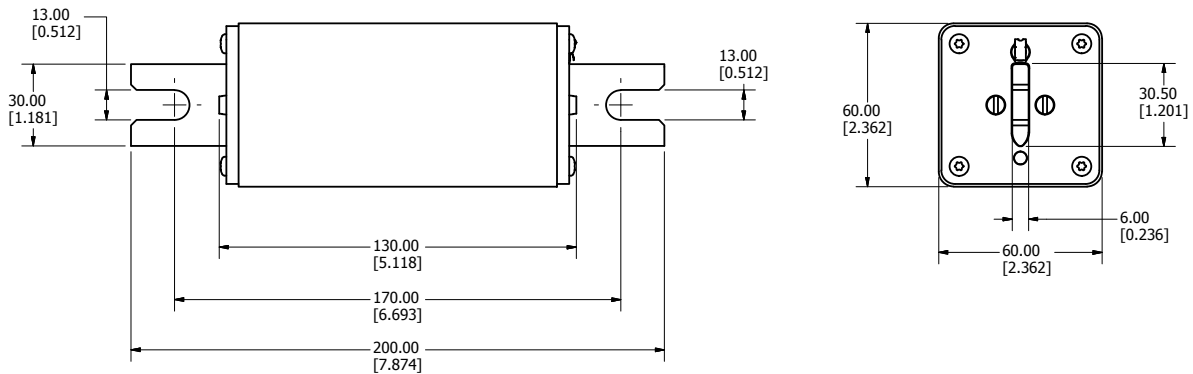

SPNH SERIES SOLAR FUSE

Dimensions Millimeters (in)

Size: 2 XL DL Blade

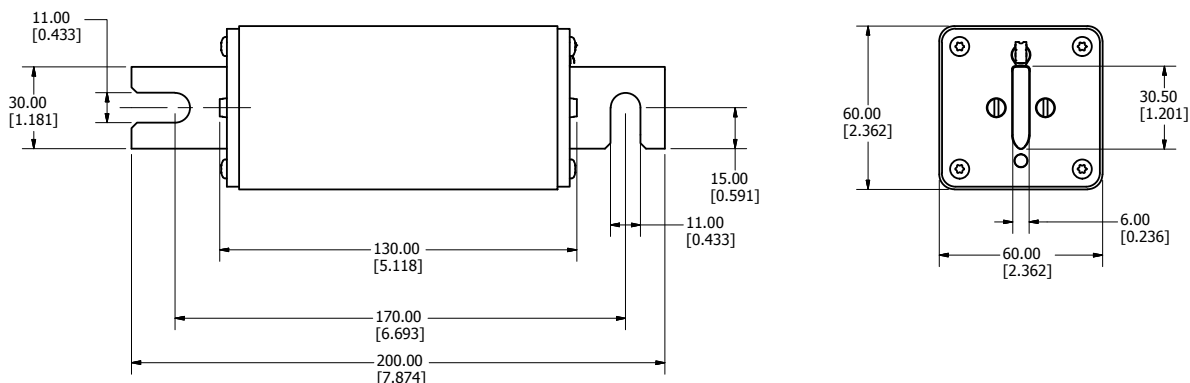

Size: 3 L DE Blade

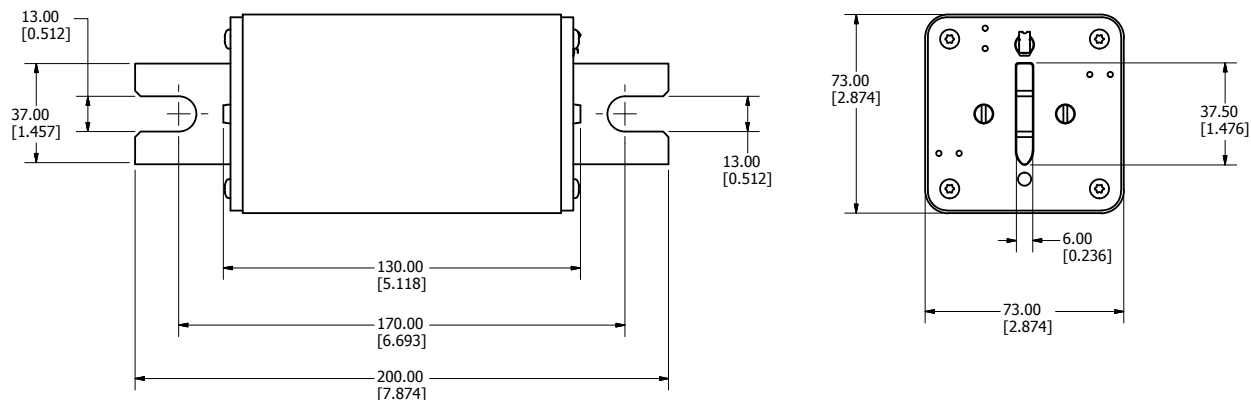

Size: 3 L DL Blade

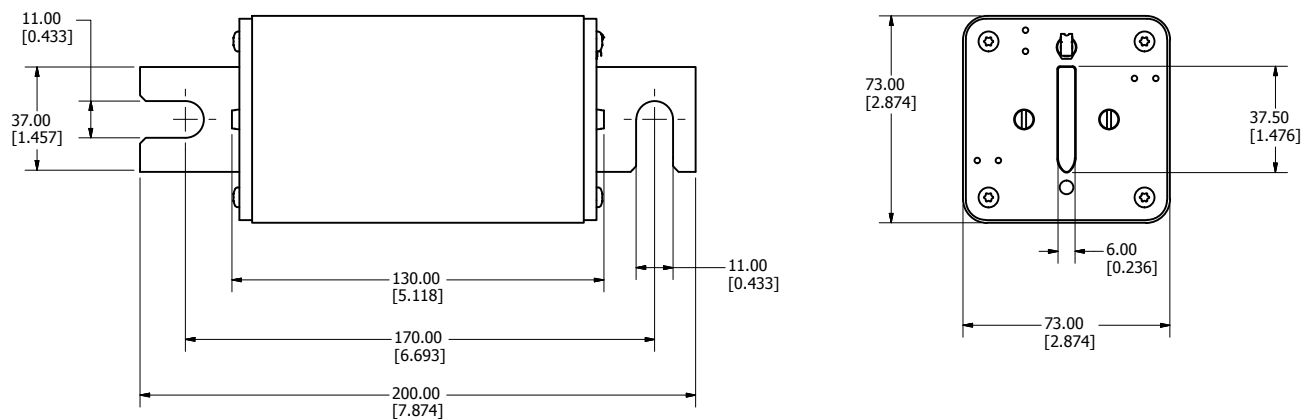

Dimensions Millimeters (in)

Size: 1 XL DL Blade w/ Microswitch Tab

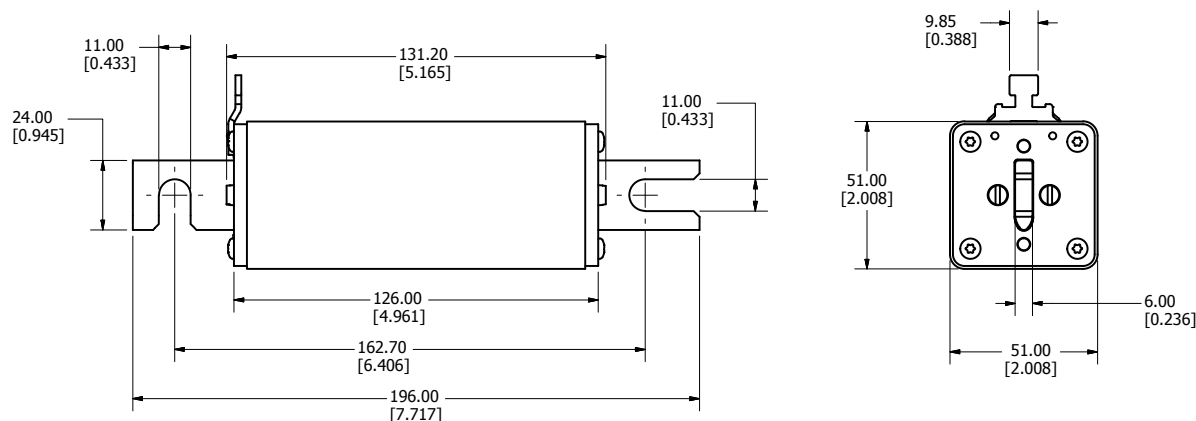

Size: 1 XL DE Blade w/ Microswitch Tab

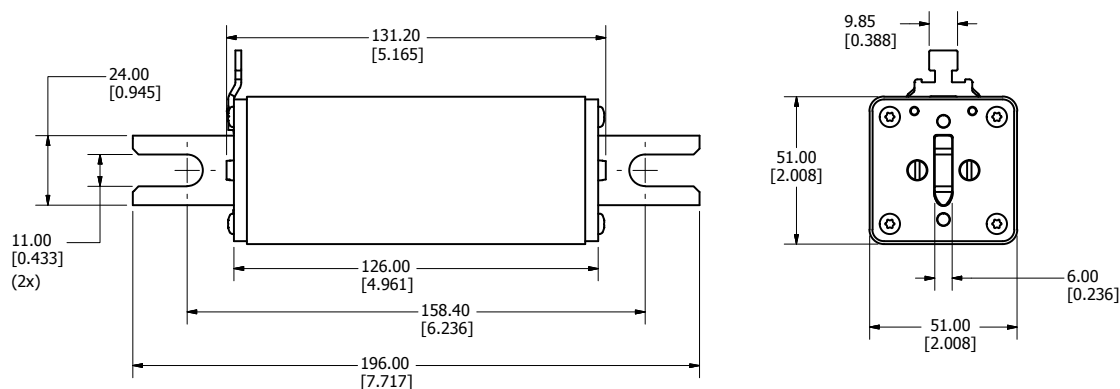

Size: 2 XL DL Blade w/ Microswitch Tab

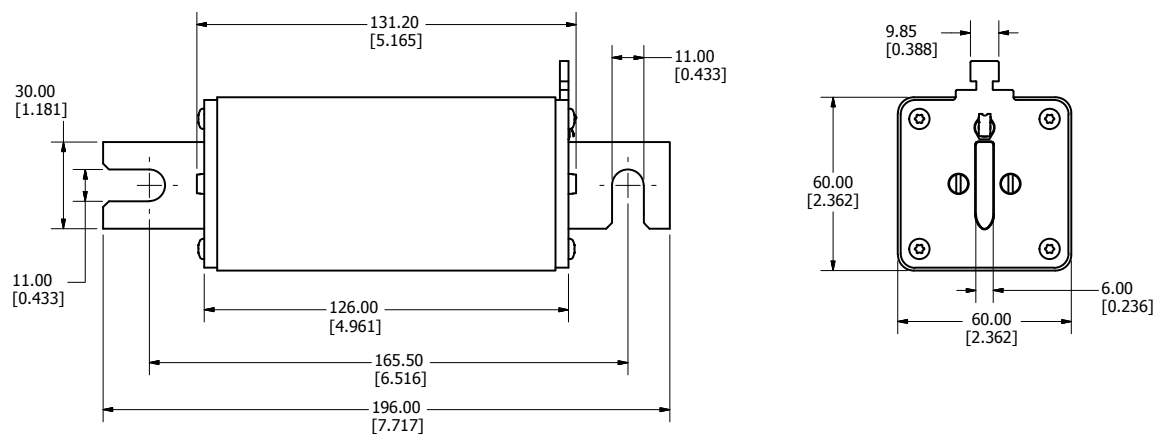

Dimensions Millimeters (in)

Size: 2 XL DE Blade w/ Microswitch Tab

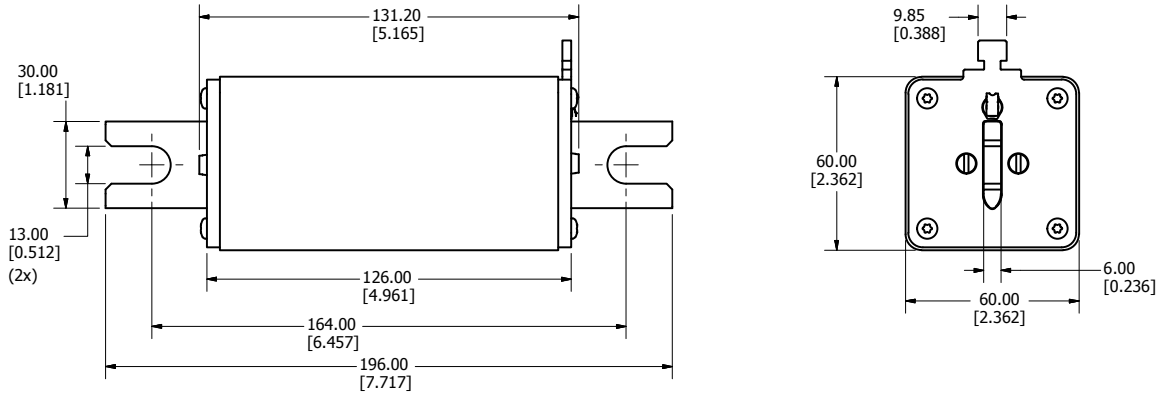

Size: 3 L DL Blade w/ Microswitch Tab

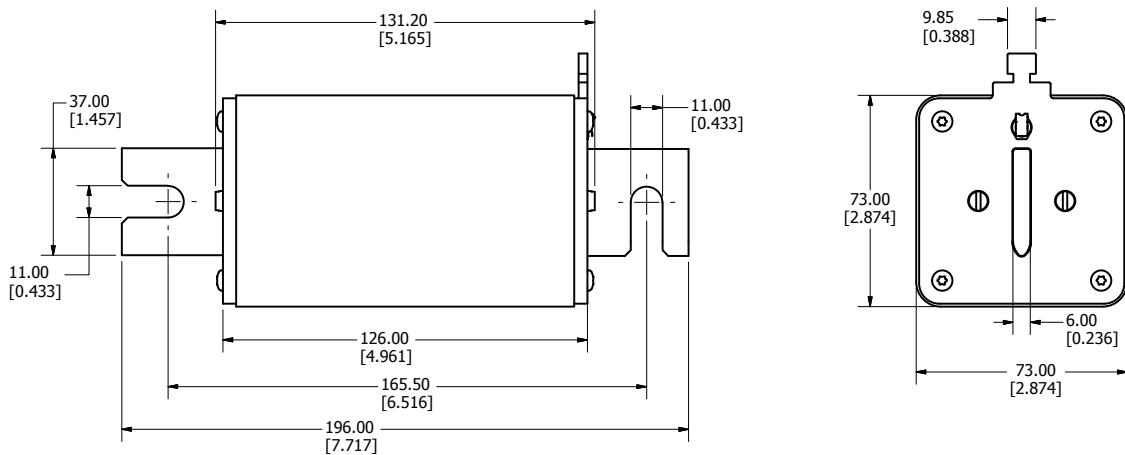

Size: 3 L DE Blade w/ Microswitch Tab

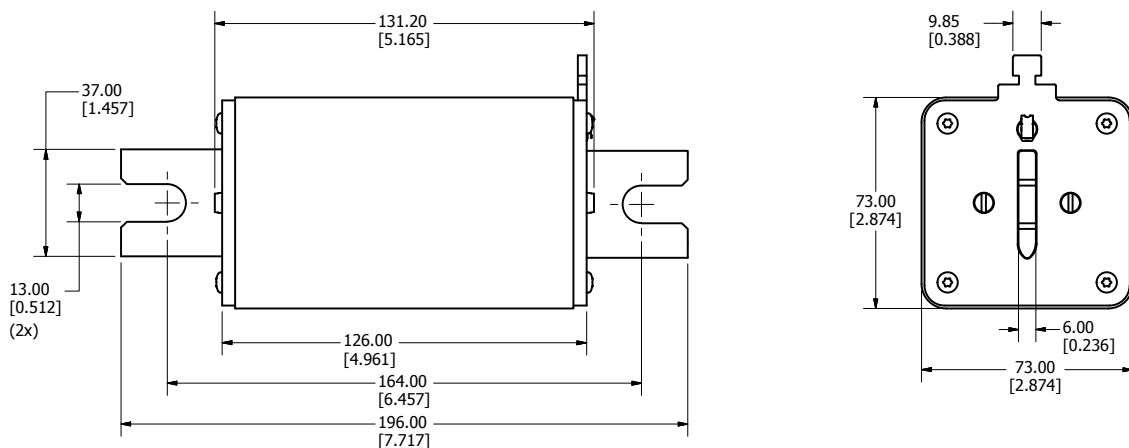

SPNH SERIES SOLAR FUSE

Electrical Specifications

AMPERAGE RATING	VOLTAGE RATING	INTERRUPTING RATING	NOM COLD RESISTANCE (mΩ)	MELTING I ² t (10 kA) (1500 Vdc)	TOTAL CLEARING I ² T (A ² s) 10 kA (1500 Vdc)	WATTS LOSS AT 100% RATED CURRENT (W)	WATTS LOSS AT 70% RATED CURRENT (W)	SIZE		
	DC	DC								
50	1500	30 kA	3.95	800	3,500	14	6	1 XL		
63	1500	30 kA	2.96	1,500	6,000	14	6.2			
80	1500	30 kA	2.36	5,000	15,000	16	7			
100	1500	30 kA	1.47	10,000	26,000	19	8.3			
125	1500	30 kA	1.07	15,000	37,000	22	9.7			
160	1500	30 kA	0.85	19,000	48,000	30	13.2			
200	1500	30 kA	0.63	22,000	75,000	32.5	13.7	2 XL		
200	1500	30 kA	0.66	42,000	75,000	36	15.9			
250	1500	30 kA	0.51	73,000	132,000	44	19.3			
315	1500	30 kA	CONSULT FACTORY							3 L
350	1500	30 kA	0.33	75,000	350,000	61	23.7			
400	1500	30 kA	0.28	85,000	450,000	67	26.8			

SPNH SERIES SOLAR FUSE

Ordering Information

CONTACT	CASE SIZE	AMPERAGE RATING	AMP CODE	CATALOG NUMBER	ORDERING NUMBER	UPC	MICROSWITCH COMPATIBLE CATALOG NUMBER	MICROSWITCH COMPATIBLE ORDERING NUMBER	MICROSWITCH COMPATIBLE UPC	AGENCY APPROVALS	
										UL	
SOLID BLADE	1XL	50A	050	SPNH050	SPNH050.X	07945804294	SPNH050	SPNH050.X	07945804294	•	
		63A	063	SPNH063	SPNH063.X	07945804295	SPNH063	SPNH063.X	07945804295	•	
		80A	080	SPNH080	SPNH080.X	07945804319	SPNH080	SPNH080.X	07945804319	•	
		100A	100	SPNH100	SPNH100.X	07945804359	SPNH0100	SPNH0100.X	07945804359	•	
		125A	125	SPNH125	SPNH125.X	07945804433	SPNH0125	SPNH0125.X	07945804433	•	
		160A	160	SPNH160	SPNH160.X	07945804443	SPNH0160	SPNH0160.X	07945804443	•	
	2XL	200A	200	SPNH200	SPNH200.X	07945804552	SPNH0200	SPNH0200.X	07945804552	•	
		200A	200	SPNH200-2XL	SPNH200.X2XL	07945819771	SPNH0200-2XL	SPNH200.X2XL	07945819771	•	
		250A	250	SPNH250-2XL	SPNH250.X2XL	07945819772	SPNH0250-2XL	SPNH250.X2XL	07945819772	•	
		3L	315A	315	SPNH315-3L	SPNH315.X3L	07945821115	SPNH0315-3L	SPNH315.X3L	07945821115	•
			350A	350	SPNH350-3L	SPNH350.X3L	07945821116	SPNH0350-3L	SPNH350.X3L	07945821116	•
			400A	400	SPNH400-3L	SPNH400.X3L	07945821117	SPNH0400-3L	SPNH400.X3L	07945821117	•
DL BLADE (S)	1XL	50A	050	SPNH050-DL	SPNH050.XXDL	07945819843	SPNH050-DLMS	SPNH050.XXDLMS	07945823539	•	
		63A	063	SPNH063-DL	SPNH063.XXDL	07945819844	SPNH063-DLMS	SPNH063.XXDLMS	07945823539	•	
		80A	080	SPNH080-DL	SPNH080.XXDL	07945819845	SPNH080-DLMS	SPNH080.XXDLMS	07945823543	•	
		100A	100	SPNH100-DL	SPNH100.XXDL	07945819846	SPNH0100-DLMS	SPNH0100.XXDLMS	07945823545	•	
		125A	125	SPNH125-DL	SPNH125.XXDL	07945819847	SPNH0100-DLMS	SPNH0125.XXDLMS	07945823547	•	
		160A	160	SPNH160-DL	SPNH160.XXDL	07945819848	SPNH0160-DLMS	SPNH0160.XXDLMS	07945823549	•	
	2XL	200A	200	SPNH200-DL	SPNH200.XXDL	07945819849	SPNH0200-DLMS	SPNH0200.XXDLMS	07945823553	•	
		200A	200	SPNH200-2XLDL	SPNH200.X2XLDL	07945819850	SPNH0200-2XLDLMS	SPNH0200.X2XLDLMS	07945823551	•	
		250A	250	SPNH250-2XLDL	SPNH250.X2XLDL	07945819851	SPNH0250-2XLDLMS	SPNH0250.X2XLDLMS	07945823555	•	
		3L	315A	315	SPNH315-3LDL	SPNH315.X3LDL	07945821118	SPNH0315-3LDLMS	SPNH0315.X3LDLMS	07945823557	•
			350A	350	SPNH350-3LDL	SPNH350.X3LDL	07945821119	SPNH0350-3LDLMS	SPNH0350.X3LDLMS	07945823559	•
			400A	400	SPNH400-3LDL	SPNH400.X3LDL	07945821120	SPNH0400-3LDLMS	SPNH0400.X3LDLMS	07945823561	•
DE BLADE (U)	1XL	50A	050	SPNH050-DE	SPNH050.XXDE	07945819852	SPNH050-DEMS	SPNH050.XXDEMS	07945823538	•	
		63A	063	SPNH063-DE	SPNH063.XXDE	07945819853	SPNH063-DEMS	SPNH063.XXDEMS	07945823540	•	
		80A	080	SPNH080-DE	SPNH080.XXDE	07945819854	SPNH080-DEMS	SPNH080.XXDEMS	07945823542	•	
		100A	100	SPNH100-DE	SPNH100.XXDE	07945819855	SPNH0100-DEMS	SPNH0100.XXDEMS	07945823544	•	
		125A	125	SPNH125-DE	SPNH125.XXDE	07945819856	SPNH0125-DEMS	SPNH0125.XXDEMS	07945823546	•	
		160A	160	SPNH160-DE	SPNH160.XXDE	07945819857	SPNH0160-DEMS	SPNH0160.XXDEMS	07945823548	•	
	2XL	200A	200	SPNH200-DE	SPNH200.XXDE	07945819858	SPNH0200-DEMS	SPNH0200.XXDEMS	07945823552	•	
		200A	200	SPNH200-2XLDE	SPNH200.X2XLDE	07945819859	SPNH0200-2XLDEMS	SPNH0200.X2XLDEMS	07945823550	•	
		250A	250	SPNH250-2XLDE	SPNH250.X2XLDE	07945819860	SPNH0250-2XLDEMS	SPNH0250.X2XLDEMS	07945823554	•	
		3L	315A	315	SPNH315-3LDE	SPNH315.X3LDE	07945821121	SPNH0315-3LDEMS	SPNH0315.X3LDEMS	07945823556	•
			350A	350	SPNH350-3LDE	SPNH350.X3LDE	07945821122	SPNH0350-3LDEMS	SPNH0350.X3LDEMS	07945823558	•
			400A	400	SPNH400-3LDE	SPNH400.X3LDE	07945821123	SPNH0400-3LDEMS	SPNH0400.X3LDEMS	07945823560	•

SPNH SERIES SOLAR FUSE

Temperature Derating Curve (Temperature of Air Immediately Surrounding Fuse)

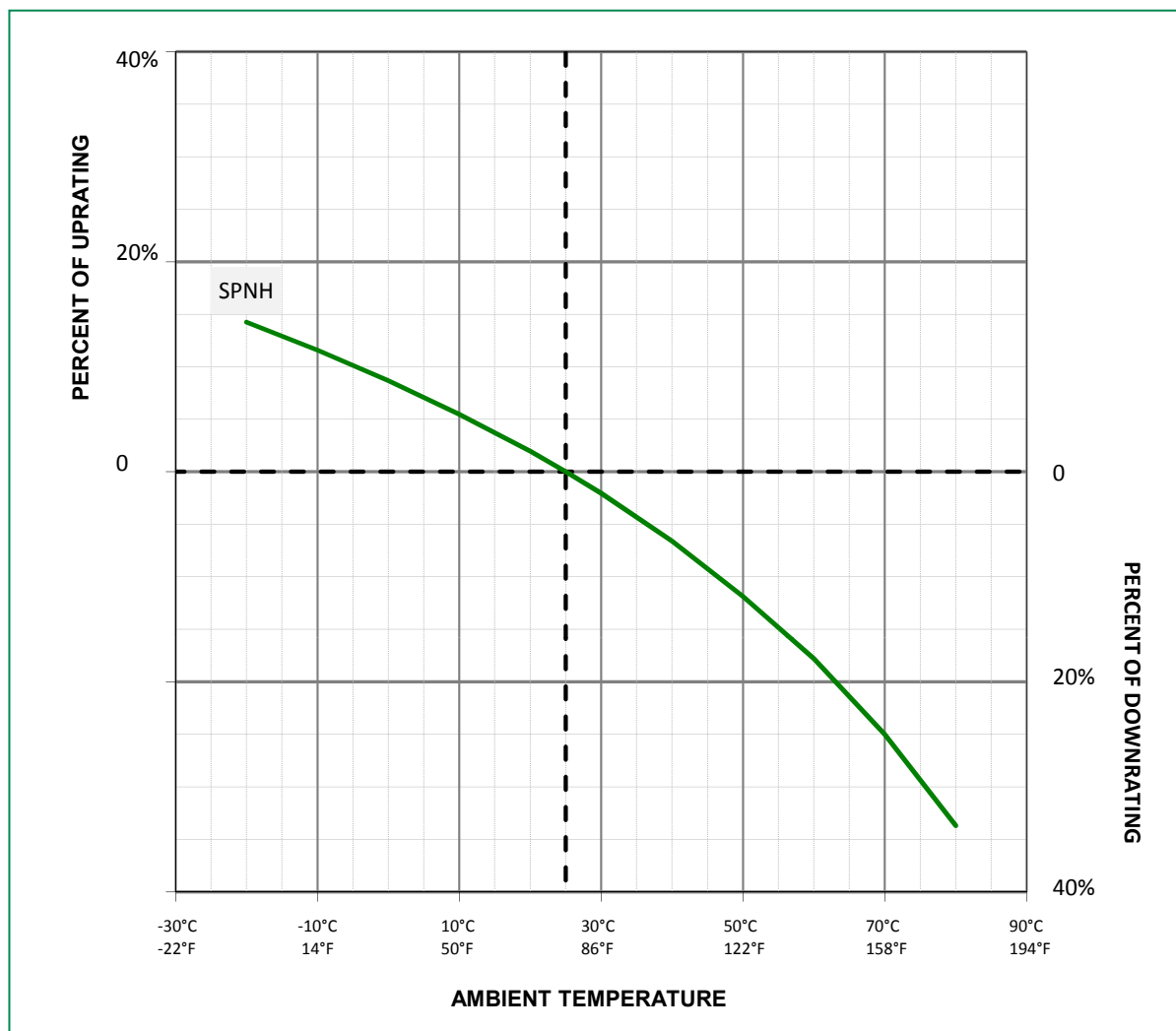

SPNH SERIES SOLAR FUSE

Time Current Curve

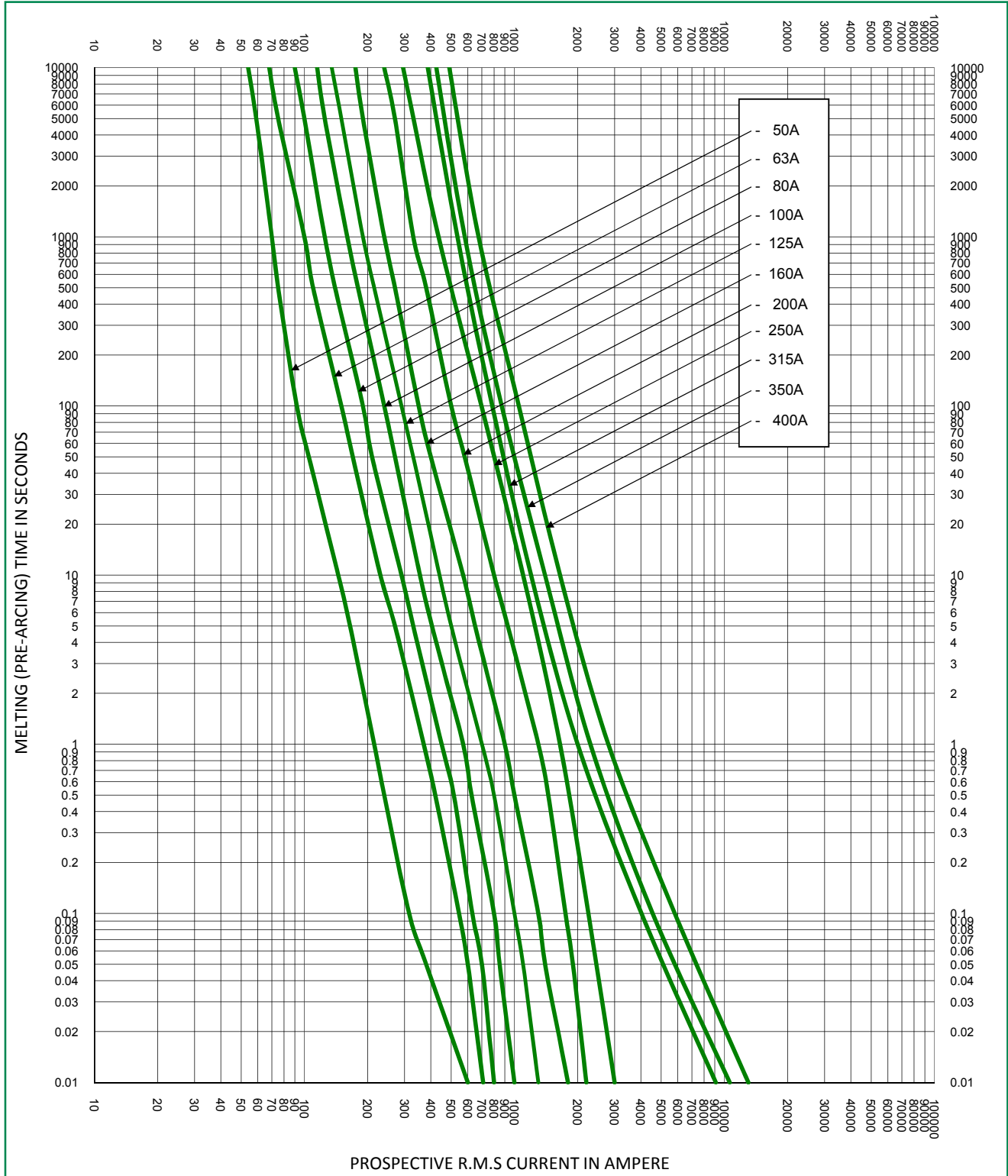

SPNH SERIES SOLAR FUSE

Microswitch

MSSPNH1500X

Dimensions Millimeters (in)

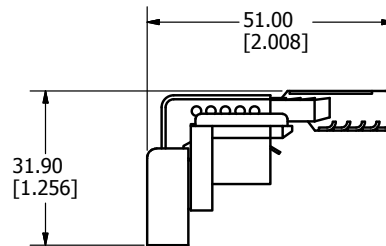
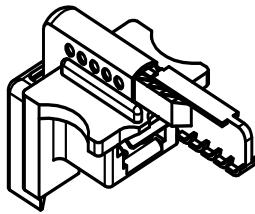

Disclaimer Notice – Information furnished is believed to be accurate and reliable. However, users should independently evaluate the suitability of and test each product selected for their own applications. Littelfuse products are not designed for, and may not be used in, all applications. Read complete Disclaimer Notice at www.littelfuse.com/product-disclaimer.